

Pipe clamps, twin series

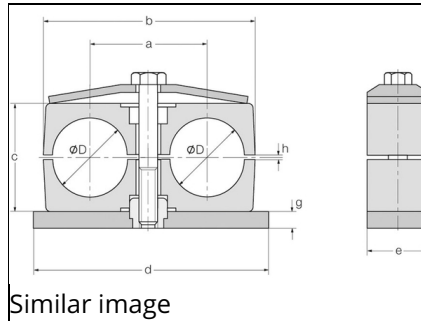

Art. No.:

RS-CF2-16

List number: 16202250

Product info

Specifications

Color:	green
DIN:	2
Series:	CF2
Ø D metric [mm]:	16,0
Ø D inch:	5/8
Width b [mm]:	53
Height c [mm]:	26
Depth e [mm]:	30
Material:	Polypropylene
Product title long:	Basic material for pipe clamps
clamp half clearance [mm]:	0,7 up to 2,5

Benefit

fast, easy pipe and hose assembly
 Vibration and soundproofing qualities
 Shock and vibration absorption
 Good weatherability
 High level of availability, directly from stock

Reserve technical changes.